

World leaders

in greens care attachments

Ask for a
**FREE
DEMO**



Solutions

Trust us to create the perfect solution for your grass, ground and turf maintenance requirements.



As the company celebrates its 50th year, we are still striving passionately to provide you with innovative solutions that measurably out-perform other methods and machinery. GreenTek equipment also gives you more for your money, with versatile multi-purpose products that can be configured to do many different tasks.

All backed up by our **Nationwide Dealer Network** and covered by our **12 Month Money Back Guarantee** which is totally unique in this industry.

"We guarantee that every GreenTek turf maintenance product will do exactly what our literature claims – otherwise we will collect it and refund your payment 100% in full, right up to 12 months after purchase!"

Trust GreenTek – your turf deserves the best!



Our Core Principles



Simple

We are here to help you. Our objective is to work with you, to understand the challenges that you face in your job, and to come up with innovative and cost effective solutions to meet your requirements.



On Time

We are well aware that the times when you need turf maintenance equipment can often be as the result of an unexpected change in weather, particularly in the run-up to an event. Our team is used to dealing with urgent requests, and we will always do our utmost to help you.



Honest

The GreenTek range includes an ever-expanding selection of specialized equipment, and we will do our utmost to come up with the ideal solution for your needs. But if we can't, we will honestly tell you. We are not here to sell you something that doesn't fulfil your requirements.



Quality Service

We believe that our customers deserve prompt and friendly service, right from their initial inquiry and for ever after. This includes arranging a demonstration when required, delivering the goods on the agreed date, and providing on-going quality customer service. After the sale, we aim to provide you with the best warranty and technical advice in this industry.



Turf Maintenance Solutions

Dyna-Seeder
6



Easy-Load
28



Multi-Brush
38



Double-Quick
46



Dyna-Corer
8



Greens Groomer MK2
30



Multi-Roller
40

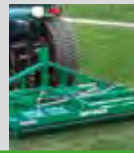

Aero-Quick
50



Dyna-Spiker
10



Greens Groomer Synthetic
32



Multi-Sarel
41



Smooth Lap
52



Dyna-Brush
11



Greens Groomer 12
33



Fairway Groomer 12
42



Low Loading Trailer
53



Thatch-Away
12



Sarel Roller & Brush
34



Fairway Groomer 6
43



Thatch-Away Walk Behind
22



Multi-Mount
35



Bunker Drainer
44



Select-A-Vibe
24



Maxi-Brush
36

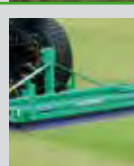

Greens Brush
45

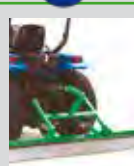

Ground Protection Solutions

Matrax
54



MaxiTrack
56



MultiTrack
58



LiteTrack
60



GeoGrid
61



FastCover
62

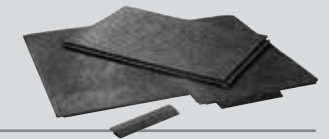

Dyna-Seeder



WATCH THE
VIDEO 



Put fresh life into your greens

If your greens are slowly filling up with Poa Annua, when really you are wanting to increase the percentage of bent and fescue in them, here's the easy way to do it. Simply Dyna-Seed them.

Overseeding is like a blood transfusion that puts fresh vigorous new growth into your turf. The problem that greenkeepers usually face with overseeding is that their members object to the disruption, so they have to wait till too late in the year when the warmth has gone out of the soil, and then they don't get proper germination. This is a huge waste of expensive seed.

The new Dyna-Seeder units open up a totally different opportunity. Because they fit so discreetly on your triple mower, your members won't even notice what you are doing, thus letting you do it when the soil is warm. Their super precise mechanism can plant pure bent seed at just 5g per metre, accurately and without wind drift.



Special trolleys store the Dynamics units when not in use, and enable them to be fitted to the mower with ease.

How the revolutionary Dyna-Seeder works...

The vibra-spiker mechanism vibrates the spikes into the ground which produces thousands of clean open holes for the seed to lodge and germinate in.

At the same time the seed is precisely metered out onto the green at the most economical application rate and pushed into the ground by the rotating spikes as they penetrate.

The precision seeding mechanism has a wide range of pre-set application rates which will handle bent seeds, fescue seeds and mixtures. Even pure bent can now be accurately and economically sown, without wind drift.

Enjoy the excellent germination rate, and fresh dense growth on your greens!

"Fescue seeds clearly in the holes made – saved about 2/3 normal amount of seed"

"80% germination of Bent seed after 2 weeks"

"Ask for a demo on your course NOW!"

Dyna-Corer



WATCH THE VIDEO 



Fast micro coring with your greens triple mower

Now that is revolutionary!
A greenkeepers' dream!

Hollow coring using a triplex, so quick and clean that the members will hardly notice it being done.

The Dyna-Corer's micro tines effectively remove thousands of tiny core plugs. An ideal thatch control or pre-seeding treatment. The coring depth can be precisely adjusted down to a maximum of 25mm.

Interchangeable solid tines are also available, plus NEW cross tines.

"One of those pieces of equipment that comes available every few years and is "Wow!" and it changes the way you maintain your greens."

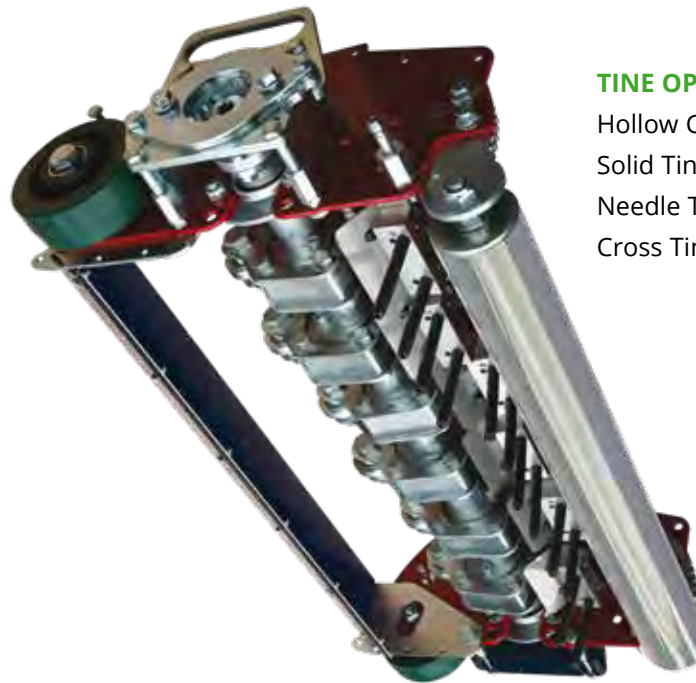

TINE OPTIONS

Hollow Core Tines
Solid Tines
Needle Tines
Cross Tines

Solutions...

- Relieves surface compaction
- Prevents surface sealing to enable air and water to reach the root zone
- Effective thatch removal in dry weather without risk of cracking from deep grooving
- Excellent preparation before seeding
- Exceptionally smooth and quiet in operation



The side-ejection tines remove thousands of neat cores.

"Ask for a demo on your course NOW!"



The discreet way to micro core your greens without your members noticing or objecting – do it with your greensmower!

Dyna-Spiker



WATCH THE VIDEO 



Solutions...

- Penetrates when the ground is too hard for even Sarel Rollers to have an effect
- Allows air, water, wetting agents and fertiliser to revitalise the roots and keep the turf healthy
- Can be used any time of year with minimum disturbance

Powered spiker & slicer

Similar to a Sarel Roller, but utilising a patented powered vibration principle, the Dyna-Spiker drives its spikes deeper into the root zone, and opens up a longer slit.

When golf greens become hard in summer drought conditions, the Dyna-Spiker's vibratory spiking action is the solution, powering its spikes through the hard surface and deep into the root zone.

These versatile units provide you with an effective means of opening up parched greens to enable irrigation, wetting agent or fertiliser to penetrate.

This machine is an exceedingly versatile item of aeration equipment that you can use all season long, giving you excellent value for money.

"Wow - there is absolutely no disturbance!"

"Nothing else penetrates as deep without using a tractor mounted implement."

"Ask for a demo on your course NOW!"



The Dyna-Spiker produces neat deep slits and an undisturbed surface.

Dyna-Brush



The Dyna-Brushes are ideal for collecting aeration cores.



WATCH THE VIDEO 



Solutions...

- Collects dead grass, clippings and even pine needles from within the turf
- Sweeps up mini-cores and similar debris to leave a perfectly clean surface
- Contra-rotating action stands the grass up

Contra-rotating brush units

These units incorporate a reverse drive gearbox so that the brushes rotate the opposite way to the direction of travel. This gives the brushes superior performance for cleaning out debris from within the turf surface, and stimulates a healthy erect sward. The Dyna-Brush units are the ideal partners for the Dyna-Corers for golf courses that want perfectly clean greens in the minimum time and with no disruption or disturbance.

"Very impressed with the Dyna Brush - it worked wonders, standing up the grass and cleaning out the sward."

"Collected the Dyna-Corer's cores even though they were very wet - amazing!"

"Ask for a demo on your course NOW!"

Thatch-Away

WATCH THE
VIDEO 





Checking root-zone samples on each green reveals the extent of your thatch layer.

Every greenkeeper's essential "must have"

Thatch is the number one enemy of good putting surfaces. This layer of excess organic matter holds water, and therefore encourages shallow-rooted *Poa Annua* to dominate the turf. Thatch produces a surface that is soft and spongy when damp, yet quickly dries out and turns yellow at the first sign of a drought.

It is not by coincidence that almost all of the top golf courses in Europe use the Thatch-Away Supa-System.

Good news travels fast, and the Thatch-Aways' awesome ability to cleanly remove and collect up thatch has made them legendary.

"Ask for a demo on your course NOW!"

Thatch-Away

WATCH THE
VIDEO 



The world's most effective Thatch collecting verticutter

There is just nothing to compare with the Thatch-Aways' unique ability to cleanly cut out and collect up thatch. And on top of that, the way they leave the surface beautifully groomed and immediately playable.

But there's also much more that the Thatch-Away Supa-System will do – just as easily and effectively.

The Supa-System is the perfect partner for your greens triple mower, and maximises its usefulness like nothing else does.

Have you got the full System yet, or are you still building yours up?



Available to fit all popular greens mowers

"Ask for a demo on your course NOW!"



Thatch-Away - it does exactly what it says!



Solutions...

- Complete triplex-operated greens maintenance system
- Saves huge amounts of man-hours and money
- Unmatched verticutting and collecting performance
- Improved turf texture gives faster green speeds
- Safe and secure cassette change. No tools needed

Verticutter

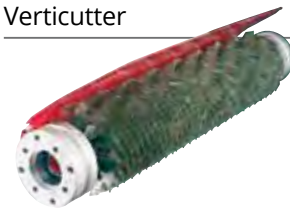

Groomer / Poa Buster



Sarel Roller



Topdressing Brush



Fine-Grass



Scarifier



Star Slitter



Greens Roller



Bermuda Tamer



Deep Slicer



Rotary Brush



"Need a new cassette designing for a particular task? Please talk to us"

Change cassettes while your Thatch-Aways are still on your mower!

Because the new Toro TriFlex* does not use grassbox carrier frames like previous models did, it provides far better access to the units. This enables the Thatch-Away Supa-System cassettes to be swapped with the units still on the mower, if the user so wishes. And thanks to the new quick motor mounting design, the whole operation can be done in just seconds – without any tools!

* Manufacturer's names used for purpose of identification only. No association implied.



The new Toro TriFlex does not have grass box carrier frames like previous models did (right). This enables clear access for changing cassettes with the units still on the mower - even the centre unit!

“Ask for a demo on your course NOW!”



1



Open the unit.

2



Remove the cassette.

3



Fit the next cassette.

4



Latch up the unit.

FREE Storage Rack

If you haven't already got one of these smart storage racks in your maintenance facility, you ought to have!

Simply order two extra sets of cassettes and we'll give you this rack, **FREE OF CHARGE** with our compliments.



Cassettes for every task...

"Our agronomist views them as essential equipment on every course"

WATCH THE VIDEO 



Verticutter

For a Thatch-Free Surface

With their revolutionary Fan-Force® Tungsten tipped blades spaced at just 10mm apart, the Verticutter Cassettes **will remove and vacuum up an incredible amount of thatch**. They leave an impeccably groomed surface which is **smooth and fast**. Most courses use them set between 0-3mm working depth. Maximum depth is 6mm.



Fine-Grass™

For Fine Fescue and Bent

The Fine-Grass cassette has **ultra thin 1mm tungsten tipped blades** at 15mm wide spacings. Specially designed for **preventing thatch from building up in fine fescue and bent grasses**. Typical working depth 1- 2mm, maximum depth 6mm.



Scarifier

For a Thatch-Free Root Zone

Periodic use of the Scarifier Cassettes set at 8-12mm deep will **remove and sweep up enormous volumes of thatch from deep within your root zone**, enabling air and topdressing to enter, and promoting microbial action that will further break down the thatch layer.



Groomer/Poa Buster™

For a Smooth Textured Surface

To thin out and refine coarser grasses, particularly Poa Annua, the Groomer/Poa Buster Cassettes have specially thin blades with offset Tungsten tips that cut at just 5mm spacings. Used at a 0-2mm working depth they encourage fine textured turf.



Deep Slicer

For Vigorous Roots & Growth

To prune the grass roots stimulating vigorous new growth, and to enable air to penetrate even deeper into the root zone allowing gas exchange to take place, the Deep Slicer Cassettes cut **continuous 20mm deep slits in the green**.



Star Slitter

For an Aerated Root Zone

The Star Slitter Cassettes mounted on your greens triple mower provide **a fast way of aerating to a depth of approximately 20mm**. The surface is left undisturbed and play can immediately continue.



Sarel Roller

For a Surface That Breathes

To keep your turf growing strongly in **Summer or drought periods** when the surface tends to get sealed over, the Sarel Roller Cassettes **allow entry for irrigation water and nutrients to a depth of approximately 20mm**. They are also an ideal preparation for overseeding.

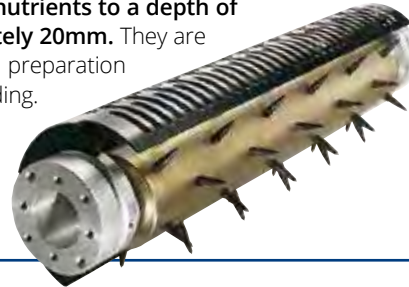

Greens Roller

For Faster Smoother Greens

A regular light rolling of your greens enables you to **maintain a smooth fast surface without mowing so close**. These solid steel roller cassettes fit straight into the Thatch-Away Supa-System units, providing you with a **highly effective greens roller for minimum expense**.



Rotary Brushes

For a Gently Brushed Surface

The **soft** black rotary brush cassettes are ideal for **removing dew, wormcasts and light debris** throughout the year. The **stiffer** blue version will additionally collect the coarser residues left **after deep scarifying, coring and brushing-in topdressing**.



Bermuda Tamer™

Keep Bermuda Healthy

Keeping Bermuda grass healthy and manicured is a challenge, but the Bermuda-Tamer cassette provides an unbelievably powerful way of keeping this aggressive grass under control. Thousands of high tensile steel bristles **give a superbly groomed surface and a smooth true ball roll**.



Topdressing Brush

For Evenly Dispersed Topdressing

The Topdressing Brush Cassettes **follow the contours of your greens to evenly brush-in your topdressing** without scraping it off the crowns and dumping it in the hollows like a dragmat does. They are also **ideal for standing up the grass** for an extra clean cut and the fastest ball roll.



Unique design features from the world leader



WATCH THE
VIDEO 



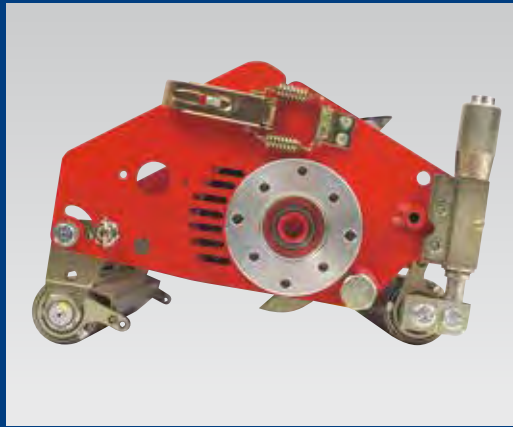

Unique B.P.S. (Blade Protection System)

This is essential because although the Tungsten tips will withstand the most abrasive sand root zones, they can be easily knocked off when sliding the units sideways under the mower to fit them. The B.P.S. prevents this happening by using a two position rear roller which raises the blades right off the floor when not in use. Patented.

"Ask for a demo on your course NOW!"



Tungsten tipped FanForce® blades.



Vacuum fan blade spacers Patented.



Unique **Set By Feel™** height adjustment.



Simple, safe and secure cassette changeover.

NO crawling under the greensmower

NO tools needed

NO bolts (to forget to tighten)...

So **NO CHANCE** of cassettes falling out on the green!

Patented

Thatch-Away Walk Behind



Nothing comes close!

The Thatch-Away 24" and 30" Walk Behind Verticutters are designed to give you the highest performance available in any pedestrian verticutter.

This is achieved by the use of patented Fan-Force Tungsten tipped blades that create a powerful air vortex which literally sucks up the thatch from your green and blasts it into the grassbox, leaving a debris-free surface. Many other features set the Thatch-Away apart, including the precision manufactured rear roller with a true differential, and the rear roller scraper that incorporates a special trough to actually collect the debris it removes.

In addition, a quickly inter-changeable Brush Reel is available for the Thatch-Away. This is ideal for when you wish to give the surface just a gentle grooming, or to remove surface debris and Poa Annuua seeds.

***"Ask for a demo on
your course NOW!"***

WATCH THE
VIDEO 





Rear roller scraper trough collects debris as you go.



Tungsten tipped blades and finned spacers for ultimate cutting and collection performance.



Look at the finish - and all that thatch!

Solutions...

- 605 tungsten tips work across the 24" cutting width for fast effective thatch removal
- Unique Fan-Force blade design literally sucks thatch out of the turf and blasts it right to the back of the grass box
- Powerful 5.5hp Honda engine for rugged reliability
- Complete with large capacity grass box

Thatch-Away Walk Behind (Patented)

	24"	30"
Engine	Honda GX160	Honda GX160
Power	5.5hp	5.5hp
Working width	61cm (24")	75cm (30")
Transport width	102cm (40")	120cm (47")
Blades	Fan-force® Tungsten Carbide tipped blades	
Blade Spacing	10mm (3/8")	20mm (3/4")
Working depth	Down to 6mm (1/4") below surface level	
Weight	120kg	135kg
Grassbox and transport wheels	Standard	Standard
Brush Reel	Optional	Optional
10mm spaced blades	Standard	Optional
Complete 10mm spaced reel	Standard	Optional
Complete 20mm spaced reel	Optional	Standard

"A very good machine. I was surprised at the amount of debris the machine picked up. We also bought the brush attachment and again this gave good results."



Select-A-Vibe

*"Ask for a demo on
your course NOW!"*



WATCH THE
VIDEO 



The best greens rollers in the world

It is not just the fact that Select-A-Vibe rollers produce measurably smoother and faster greens than other types of rollers that makes them the best choice. They are the **logical choice** in every way.

They are faster in use than other rollers, because they cover a full 1.5m (5') width. Their three individual 22" units follow contours, just like your mower does. And you drive them facing straight ahead, which means they leave straight stripes behind, and give you the assurance that all levels of staff can use them safely.

And they are **so easy** to use! You don't have to sit sideways and screw your neck back and forth as you zigzag from side to side across the green. You **don't** struggle for traction on wet slopes. And you **don't** have to hitch up to a utility vehicle to drive from one green to the next. Nor do you have to buy petrol for them, because they operate on your diesel greensmower.

On top of which you can also do so many other tasks with them because of their unique **variable** vibratory action...

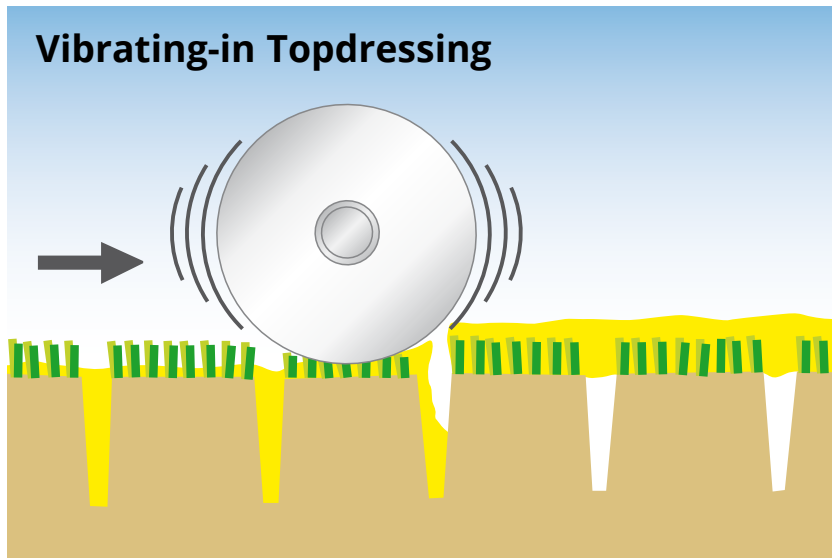

There is nothing like a combination of drag brushing and vibratory rolling for filling your coring holes. And by getting the topdressing further down into the surface, you stop it blunting your mower's blades as much, dramatically reducing downtime and regrinding costs.

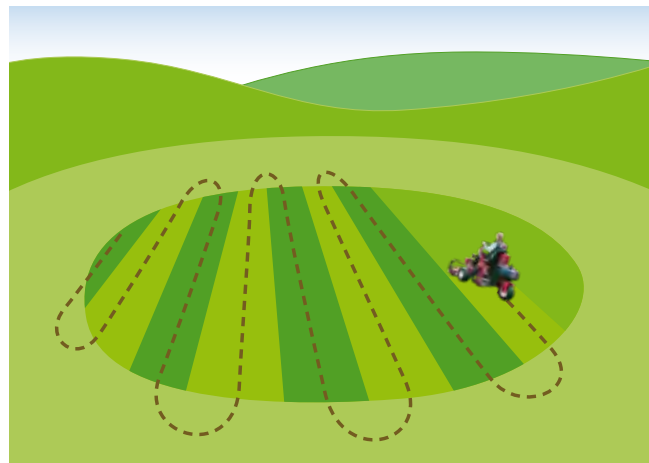

The three units follow contours and leave straight full-width stripes, just like your mower does.



Full 1.5m (5') rolling width enables you roll greens quick enough to keep ahead of the players.

Solutions...

- Three individual 22" roller units
- Follow your greens' contours just like your mowers do
- Roll straight stripes that match your mowing width
- Quick to use and to transport from green to green
- Vibrate-in topdressing without bridging over coring holes
- The most operator-friendly greens roller available

Select-A-Vibe

WATCH THE
VIDEO 



*"Ask for a demo on
your course NOW!"*



For consistently fast greens

Do all your greens stimp at the same speed? They can do!

The Select-A-Vibe rollers give you a unique advantage over any nonvibratory type of roller, in that their vibratory action enables you to even out speed inconsistencies between greens. By varying your speed of travel as you are rolling different greens, you can vary the vibrations per metre that you apply to each, and hence the effect.

Thus by rolling at a slower speed on a slow green, and faster on a fast green, the greenspeeds of both can be equalised. Wouldn't your golfers like that?



Only Select-A-Vibes can do all this for you...

Vibration Power Levels

- 1 Establishing New Greens
- 2 Regular Rolling
- 3 Pre-Competition Rolling
- 4 Trueing Up After Aeration
- 5 Vibrating-in Topdressing

These suggested power levels are a starting point from which you can experiment and find the optimum settings to suit your particular greens conditions.



The 5 levels of vibration power are easily adjustable.



Select-A-Vibe rollers fit all popular greens mowers.



Select-A-Vibe rollers are available for both electric and hydraulic drive greens mowers.

Easy Load

WATCH THE VIDEO 



Save time and money

Twice as fast...

Customers who own the Easy-Load topdressing trailer tell us that they can now topdress **"twice as fast, with half the manpower"**.

Now you can transport your sand and load it directly into your topdresser with no manual handling.

The massive 16" flotation tyres are spaced outside of the body which gives extra stability when you are tipping in the high position.

The Easy-Load is designed to be your ideal all-round three tonne trailer. It is equipped as standard with a dual-purpose tailgate which incorporates a flow control gate and a loading chute within itself, and is also top-hinged in the conventional way. This enables you to use the Easy-Load for general tipping trailer duties as well as loading your topdresser, thus giving you maximum value from your investment.

"The Greenkeeper's best friend."

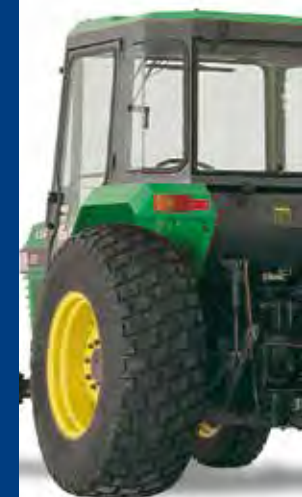



Suitable for use with modern spinner type topdressers.



“Best item of equipment I have ever purchased. It has taken hours off topdressing and bulk material moving. Easy to use for filling Cushman topdresser, freeing up two staff members for other tasks.”

Easy-Load (Patented)

Unladen weight	850kg
Load capacity	3 Tonnes
Body volume	1.83 cubic metres (65 cubic feet)
Body dimensions	2.47m (97") x 1.40m (55") x 0.53m (21")
Overall length	4.45m (14'7")
Overall width	2.32m (91")
Tyres	400/60-15.5 10 ply
Brakes	Hydraulic brakes plus manual parking brake
Optional Extras	Road lighting and mudguards

Wheels spaced outside body width provide extra stability for high tipping.

Solutions...

- Eliminates manual handling, in line with HSE -objectives
- Frees up manpower for other important jobs
- Speeds up topdressing so greens are back in play quicker
- Unique design with wheels outside of the body for maximum stability and safety



The Easy-Load can also be used as a conventional tipping trailer.

Greens Groomer Mk 2

WATCH THE VIDEO 



"The Greens Groomer is in a different league to the old dragmat or single brush."

Why brush?...

The big benefit of brushing-in topdressing, as opposed to rubbing it in with a metal dragmat, is that the brush bristles quickly work the topdressing down between the blades of grass, right into the surface. On the other hand, the design of a metal dragmat means that it tends to scrape the material across the surface and therefore can require more passes to thoroughly rub it in.

Another big benefit of the Greens Groomer is that its multiple zigzag brushes move the topdressing sideways as well as forwards, and it is therefore especially effective at filling Hollow Coring holes without scuffing or bruising the turf.

“16 separate brushes give unrivalled brushing-in and grooming performance.”

“Ask for a demo on your turf NOW!”

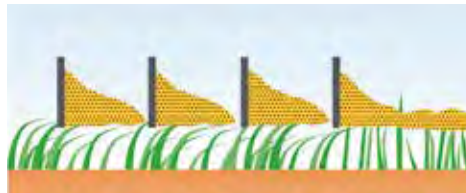

A dragmat tends to scrape the topdressing across the surface.

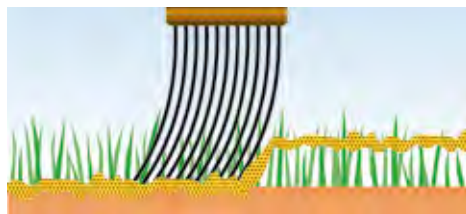

The Greens Groomer works the sand down into the surface between the blades of grass.

Solutions...

- Lifts grass for a clean-cut smooth textured surface
- Greens back in play sooner
- Removes dew before play
- Easy to fit, quick to use
- Brushes-in topdressing sand - wet or dry!
- Also excellent for maintaining synthetic and clay pitches
- Drawbar position can be easily reversed to extend brush life



Greens Groomer Synthetic



Greens Groomer with Rear Rake and Brush for rubber crumb filled pitches.

Increase the life of your synthetic pitch

The Greens Groomer has long been recognised as the most effective brush ever made for natural turf. Now that same experience is applied to Synthetic surfaces.

Very importantly, the Greens Groomer uses a unique Patented brush pattern where all 16 brushes are positioned in random Quad Zig Zag formations. No other brush has this feature which is designed to prevent tramlines being left on the turf surface.

For Rubber Crumb filled pitches, the Rear Rake and Brush attachment uses no less than 84 spring fingers mounted in three staggered rows to totally groom your pitch. And each row of rakes is adjustable, so you can vary their intensity from just a gentle combing to a thorough raking.

"Ask for a demo on your course NOW!"

Greens Groomer 12

Double the width

WATCH THE VIDEO 



Full 12' (3.6m) working width with automatic folding wings.

Solutions...

- Twice as wide – takes half the time!
- Floating brush heads follow contours
- Auto lift saves getting off to fold brushes
- 6' to 12' upgrade kit available

The 3.6m Greens Groomer 12 doubles your productivity in one go!

The extra wings float to follow the contours of your greens, enabling you to quickly brush in topdressing or disperse dew over a full 12' working width however undulating your greens or fairways are.

The auto-lift system automatically raises the wings as the transport wheels are lowered, to save you getting off and doing it manually.

If you are already using a Greens Groomer 6, why not fit the 12' upgrade kit and double your productivity?

*“Excellent.
The best we’ve used.”*

*“Ask for a demo on
your course NOW!”*

Sarel Roller & Brush

Solutions...

- Thousands of small holes pricked through sealed turf surfaces
- Decreased use of wetting agents
- Brushing disperses moisture, reducing fusarium risk
- Ideal for use before and after overseeding, to increase germination rate



How to survive droughts and downpours

In summer, turf becomes sealed by a combination of dust and foot traffic. This results in the irrigation or rainfall evaporating off without being absorbed into the root zone. And when it rains hard, a sealed surface results in a mass of puddles.

Hence the benefit of using a Sarel Roller to spike the surface followed immediately by a brush to sweep the dew down the holes into the root zone. Then when it rains, you will have an open surface that drains freely.

Sarel Roller

Working width	1.5m (5')
Weight	135kg

Rear Dew Brush

Working width	1.5m (5')
Weight	8kg

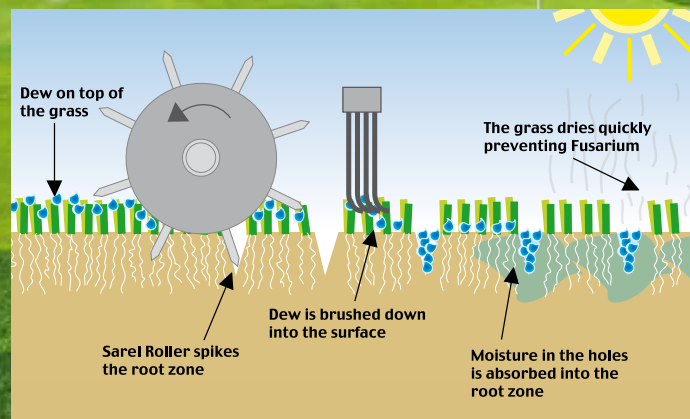

The Sarel Roller and Brush combination can help to significantly reduce your expenditure on wetting agents.

WATCH THE VIDEO



"Ask for a demo on your turf NOW!"

Multi-Mount

WATCH THE VIDEO 



Want to use your maintenance truck?

The GreenTek Multi-Mount is causing a huge shift in popularity towards using turf trucks for greens maintenance work.

The Multi-Mount is a universal frame which can be configured to suit the Cushman Truckster, Toro Workman and John Deere Pro Gator. It enables you to attach the Aero-Quick, Maxi Brush and Sarel Roller to any of these power units.

Solutions...

- Durable heavy-duty construction
- Fits all popular turf trucks
- Interchangeable fittings for different models
- Takes a wide range of GreenTek equipment



Sarel Roller and Multi-Mount on a John Deere Pro Gator.

"Ask for a demo on your turf NOW!"



Aero-Quick and Multi-Mount on a Toro Workman.

Maxi-Brush

Solutions...

- Economical and versatile
- Turf is less prone to fungus when dew is dispersed
- 6 rows of bristles quickly brush-in topdressings
- Ideal for striping pitches, grooming before mowing and dispersing worm-casts and grass clippings
- Also suitable for maintaining synthetic turf

WATCH THE
VIDEO 



The smart way to healthy turf

The importance of brushing turf is now widely recognised. It has largely replaced the use of dragmats as the best way of working-in topdressing, and is increasingly used to remove worm-casts and disperse dew, thus helping to prevent fungal diseases such as fusarium.

The Maxi-Brush is a triple section 5.4m (18') wide brush, which can also quickly adapt to a six row 1.8m (6') wide topdressing brush. Now with the introduction of optional hydraulic folding, it has become even more versatile than ever.

By brushing off the dew before mowing you get a clean cut with no grass clumps.

Very versatile

One of the great features about the Maxi-Brush is its versatility. For general sportsfield use, the manual folding version is ideal. For golf courses, optional hydraulic folding provides ultimate ease and efficiency for transport between fairways.

And if you already own a Maxi-Brush, you can now also purchase the Sarel Roller kit as an option to fit the same frame.



Hydraulic Maxi-Brush folds up without leaving your seat.

"We can brush all our fairways in 2 hours 45 minutes which allows clump free cutting."



Sarel Roller Cassette with Rear Dew Brush fits into an existing Maxi-Brush frame.

Maxi-Brush (Patented)			
	Working width	Transport width	Weight
Triple brush with manual folding	5.4m (18')	1.8m (6')	150kg
Triple brush with hydraulic folding kit	5.4m (18')	2.34 (7' 8")	180kg
Sarel Roller kit	1.5m (5')	1.8m (6')	135kg
Rear Dew Brush kit	1.8m (6')	1.8m (6')	8kg

Multi-Brush

WATCH THE
VIDEO 



The double-jointed transformer!

With its massive 5.4m (18') working width the Multi-Brush can disperse the dew and worm casts off all the fairways on an 18 hole golf course in two hours! And its three independently floating heads with unique double-jointed lift arms enable it to flow over undulations like nothing else can.

Brushing the dew off your turf daily has a double benefit. Not only do the players appreciate a dew-free surface, but it also helps prevent fungal disease such as fusarium. Then you can follow straight over with your fairway mower, leaving an evenly dispersed cut without clumps of wet clippings everywhere.

And at the touch of a lever, the Multi-Brush effortlessly transforms itself into a supremely effective 1.8m topdressing brush.



Effortlessly transforms from 5.4m fairway brush to 1.8m topdressing brush.

Multi-Brush		
Working width	Transport width	Weight
5.4m (18') or 1.8m (6')	2.1m (7')	240kg

"Ask for a demo on your course NOW!"

Solutions...

- Brushes off dew before mowing for a clean cut
- Reduces risk of fusarium
- Leaves beautiful stripes
- Brushes-in topdressing with ease
- Floats over undulations
- Folds hydraulically



The Multi-Brush is supremely effective for brushing-in topdressing.

Multi-Roller



WATCH THE VIDEO 



Solutions...

- Three separate rollers follow undulations
- Hydraulic folding for quick and easy operation
- Fits to mid size compact tractors
- Quickly restores the surface of your pitches

Fast, lightweight rolling

If you have a large area of turf that needs a regular light rolling, the Multi-Roller has been designed for just that! It has been specially developed to meet the needs of Football Academies and Sports Complexes with several pitches that require a regular light rolling to restore the surface between games.

Covering a massive 18' (5.4m) working width, and yet weighing only 650kg, the secret of its effectiveness is its small diameter rollers which give a greater rolling pressure for their weight than large diameter rollers would do.

Used in conjunction with just a mid range compact tractor, it is now possible to roll a full pitch in approximately 20 minutes!



Hydraulic folding

Multi-Roller

Working width	Transport width	Weight
5.4m (18') or 1.8m (6')	2.5m (8'2")	650kg



"Ask for a demo on your turf NOW!"

Multi-Sarel



WATCH THE VIDEO 

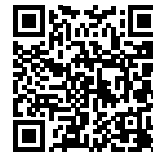

The world's widest sarel roller

Sarel rolling has long been recognized as a highly beneficial turf treatment. It keeps the turf surface open, so that it can breathe and drain, and nutrients can be absorbed.

The new Multi-Sarel has three separate units which fold out hydraulically to give a massive 5.4m working width. It can also be used folded in with all three rollers in line to give a very intensive spiking pattern. This is an ideal preparation for overseeding.

Rear brush attachments are also available so that you can spike and groom at the same time, leaving your pitches healthy and immaculately striped.



Optional rear brushes groom your turf while you spike.

"Ask for a demo on your turf NOW!"

Solutions...

- Keep your turf breathing and draining
- 5.4m working width
- Rapid coverage of large areas
- Also takes Multi-Brush and Multi-Roller units



Units can also be used folded in for intensive overseeding preparation

Multi-Roller

Working width	Transport width	Weight
5.4m (18') or 1.8m (6')	2.3m (7'6")	450kg

Fairway Groomer 12



Fairway Groomer 6



Solutions...

- Three adjustable rakes lift out thatch and debris
- Air can circulate around the grass better, reducing the risk of fungal disease
- Adjustable rear brush leaves a beautifully groomed and striped finish

The economical way to dethatch your fairways

By giving your fairways a good raking you can help to stimulate more healthy grass growth.

The Fairway Groomer is equipped with three rows of spring tines, each of which can be individually adjusted to achieve the exact degree of raking that you require. In addition, a stiff rear brush enables you to further groom the surface of your fairways and leave them with a beautifully striped finish.

Fairway Groomer 6

Working width	1.8m (6')
Weight	50kg

Fairway Groomer 12

Working width	3.6m (12')
Weight	150kg

"Ask for a demo on your turf NOW!"

Bunker Drainer



WATCH THE VIDEO 



The shaft driven pump quickly empties flooded bunkers, trenches or graves with no priming.



An additional drive shaft with a Vibrating Poker attachment is also available for concreting work.



Your solution for flooded bunkers

One thing you can't control is the weather. If you have heavy rain on the night before your big tournament, what will your bunkers look like in the morning? It's at times like this that you'll be glad you've got a GreenTek Bunker-Drainer in your shed.

This pump means business! It is not just your conventional water pump with a suction hose that is difficult to get primed, and keep flowing when the level gets low.

The Bunker-Drainer's 5hp Honda engine drives a heavy duty flexible drive shaft, with a high volume rotary impellor pump mounted directly on the end of it. Because the pump is actually in the water it needs no priming, and can handle muddy water with ease.

Bunker-Drainer

Engine	Engine Honda GX160 5hp
Drive shaft	5.0m
Pump	Heavy duty 2" submersible pump
Hose	10m of 2" layflat hose included

"Ask for a demo on your turf NOW!"

Greens Brush



Your economical solution for light brushing

If you want a quick way of dispersing dew or brushing in light topdressings, the 8' Greens Brush is ideal for your needs. It comes complete with category 1 fittings, suitable for compact tractors and an optional spring loaded adaptor enables it to fit on Cushman Trucksters. It has tough polypropylene fibre bristles, and the brushes are long lasting and easy to replace.

"Ask for a demo on your turf NOW!"

Double-Quick

“One of the best machines I have come across”





Aerate, roll, rake and brush

Aeration is proven to restore the health of compacted sports turf. Light rolling is necessary to keep the surface smooth. Raking lifts out thatch and stands the grass up allowing better air circulation which helps to reduce the risk of fungal disease, and brushing disperses dew and leaves a smart striped finish.

If you've never had time to do all these vital treatments as often as you should, now's your chance to do them all in one go. Every time you aerate you can do all four operations with no extra manpower or time taken, thanks to the Double-Quick's all-in-one Rear Roller, Rake and Brush attachment.

"Ask for a demo on your turf NOW!"

Double-Quick

Solutions...

- Relieves compaction, allowing turf to breathe - and grow!
- Opens up the soil structure and improves drainage
- Stimulates deeper roots which resist drought in summer
- Encourages stronger turf that is less likely to scuff off in winter

WATCH THE
VIDEO 



It's a Rollover !

The heart of the system is the unique Main Frame, which can carry two attachments of your choice, mounted one above the other. So you can change from Deep Slitter to Ballast Roller etc by just turning the Main Frame over.



1 Remove pins holding top guard and rear attachment.



2 Attach tow cable to tractor and Double-Quick.



3 Drive tractor forward to roll Double-Quick over.



4 Re-attach to tractor and replace top guard.

Mix And Match Your Attachments To Suit Your Needs...

Deep Slitter

With closely spaced 8½" tines, this gives a dense pattern of aeration for heavily used winter games pitches and fairways.



Fine Slitter

Even closer spaced 5" tines – to prevent surface sealing and increase the absorption of air, water and fertiliser.

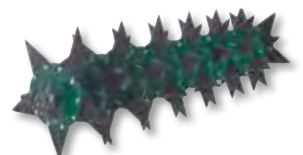

Hollow Corer

The hollow corer removes plugs of soil, letting the ground expand and decompact.

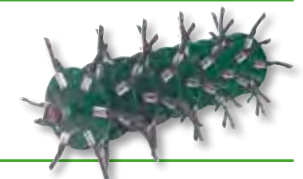

Disc Slitter

The continuous slits give maximum air and water absorption, plus they prune the grass roots to stimulate vigorous new growth.



Ballast Roller

Fill it with water for maximum effectiveness; use it part full or empty for a light rolling.

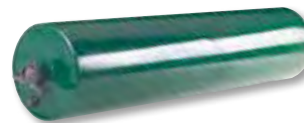

Rear Roller

Great for firming back divots after slitting.



Scarifying Rake

Fast effective thatch control, as you go. Attaches to the rear roller above.

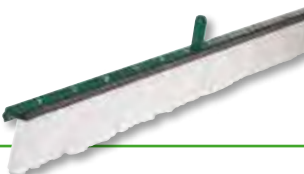

Rear Brush

Can also be attached to the Rear Roller, to leave a well groomed appearance.

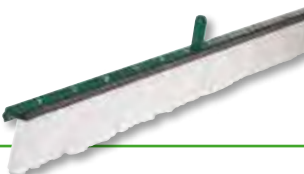

Double-Quick (Patented)

	Weight 6ft	Weight 8ft
Main Frame	200kg	290kg
Deep Slitter	122kg	160kg
Fine Slitter	129kg	170kg
Disc Slitter	38kg	50kg
Hollow Corer	120kg	170kg
Ballast Roller	180kg	200kg
(Weight of water ballast)	220kg	290kg
Rear Roller and Carrier	91kg	115kg
Rear Rake	17kg	20kg
Rear Brush	8kg	10kg
6' for 35hp + tractors; 8' for 50hp + tractors		

"Ask for a demo on your turf NOW!"

Aero-Quick

WATCH THE
VIDEO 



Grass roots don't grow in soil

Grass roots do not grow in soil, but in the air spaces between the soil particles. Compaction from regular play closes up those air spaces till the turf can neither breathe nor drain. Unless you relieve this compaction by regular aeration, the soil becomes stagnant and your turf will die.

The versatile Aero-Quick weighs only 240kg, making it light enough for even a Turf Truckster or 20hp compact tractor to handle. Yet with a full 5' (1.5m) working width, it will also cover the tracks of most tractors up to 35hp.

A wide range of different attachments is available to suit varying surfaces from golf greens to football pitches, and a built-in weight tray allows you to add further ballast for maximum penetration.



The hinged rear guard gives good access to the interchangeable attachments.

Wide range of interchangeable attachments

Slit Tinners

A wide range of different slitting tines from 5" to 8½" depths may be used on the Aero-Quick for maximum effectiveness on all types of sports turf.



- a: 8½" Outfield
- b: 8" Outfield
- c: 6" Outfield
- d: 6" Fine Turf
- e: 5" Fine Turf

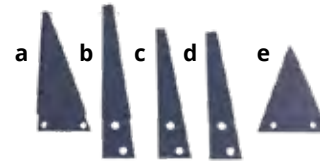

Hollow Corer

This removes plugs of soil, enabling the ground to expand and decompact. The air channels thus created also assist in the breaking down of thatch.



Disc Slitter

The continuous slits give maximum air and water absorption, plus they prune the grass roots to stimulate vigorous new growth.



Rear Roller, Rake and Brush

Modular attachments enabling you to do up to four tasks at once.



The Aero-Quick's 5' (1.5m) working width covers the track of most compact tractors and utility vehicles.

Solutions...

- Relieves compaction, allowing turf to breathe – and grow!
- Opens up the soil structure and improves drainage
- Stimulates deeper roots which resist drought in summer
- Encourages stronger turf that is less likely to scuff off in winter
- Fits to compact tractors or popular utility vehicles

"Ask for a demo on your course NOW!"

Smooth-Lap



Fine greens need sharp mowers

With a Smooth-Lap in your workshop, you can quickly hone up your blades to maintain a razor clean cut and extend the intervals between regrinds.

The drive arm quickly adjusts through an extra wide arc, so it fits all kinds of awkward driveshaft alignments with the base still firmly planted on the ground. It works in both forward or reverse motion at the flick of a switch.

Smooth-Lap

	Weight
240 V Reversible Back Lapper	24kg



Low Loading Trailer



Optional 1" thick Rubber Floor Mat.

Solutions...

- A totally versatile trailer system for all groundcare uses
- Superior fully-welded construction
- Hot dip galvanized for maximum durability
- Drive-in tailgate ramp is ideal for all kinds of small machinery

The ultimate way to transport groundcare equipment

With their drop-down tailgates providing easy loading access, the Low Loading Trailers offer you an ideal means for transporting all types of groundcare equipment and supplies, with models available for both on and off road usage.

Besides transporting mowers, these trailers can be used for tasks as diverse as carrying divot mix or collecting leaves. A range of useful accessories is available, including a sliding divider and mower clamp which can be positioned wherever required.

Standard Low Loading Trailer

Body dimensions	152 x 99 x 43cm
Overall width	162cm
Load capacity	400kg

Super Low Loading Trailer

Body dimensions	200 x 122 x 43cm
Overall width	184cm
Load capacity	600kg

Matrax

Solutions...

- High performance portable flooring
- Protects turf from damage
- Lightweight
- Easy to handle and transport
- Strong overlapped joints
- 100% recyclable



Protect your turf from the rigours of a non-sporting event!

This quick-install flooring system is ideal for a vast range of applications.

The Matrax high-performance system is custom designed for use in stadiums and other large-scale venues that wish to maximise their revenue by hosting other events.

The Matrax system has two options: HD and LD Panels which integrate seamlessly together to provide optimum turf protection for both vehicular and pedestrian traffic.



Quick lock cam fixings give rapid installation

"Ask for a demo TODAY!"

Maxtrak HD For Vehicular Access



- Vehicle and pedestrian friendly
- Closed-back design for maximum load-bearing capacity
- Supports heavy loads including delivery lorries and rigging cranes
- Anti-slip diamond tread pattern



Maxtrak LD For Pedestrian Access



- Pedestrian friendly
- Open-back design enables grass to continue growing
- Strong but lightweight for easy handling
- Translucent plastic with air holes to allow additional light, oxygen and water drainage



Specifications	
Length	1220mm
Width	1220mm
Surface Area	1.23m ²
Thickness	38mm
Weight	(Matrax HD) 22.7 kg (Matrax LD) 13.8kg

MaxiTrack



The most heavy duty man-handleable matting system in the world

MaxiTrack is uniquely ideal for protecting large areas of turf from heavy traffic. It is the most heavy duty man-handleable trackway system in the world, and is guaranteed unbreakable by vehicles up to 130 tonnes. Yet because they weigh just 40kg, these 1.8 x 0.9m mats can be easily installed by hand.

What makes them specially suited to large areas is their overlapping flange joints which provide continuous support. This helps suppress mud, and enables them to accommodate heat expansion without buckling in hot weather.

MaxiTrack is available for sale, dry hire, or fully installed – please phone 0113 267 6000 for assistance.



"Ask for a demo TODAY!"

WATCH THE VIDEO 





MaxiTrack mats quickly bolt together for rigid support.



Slotted joiners enable large areas of MaxiTrack to cope with heat expansion in hot weather.



SafeStore stillages for efficient storage and transport

Solutions...

- Superior rigidity protects the ground
- The most heavy duty man-handleable trackway system in the world
- Guaranteed unbreakable by vehicles up to 130 tonnes*
- Overlapping flanges for mud suppression
- Slotted joiners to cope with heat expansion



Built for heavy duty use

MaxiTrack mats have a 23mm thick core with treads on both sides

SMARTGRIP™



The SmartGrip tread pattern is designed for exceptional grip in all directions and is suitable for pedestrians and wheeled or rubber-tracked vehicles

Slotted joiner holes allow for heat expansion

Lapped flange joints provide a rigidly supported continuous roadway for maximum stability and minimum mud ingress



Can also be crane installed in fours

Specifications

Overall Size	1.9 x 1.0m
Surface Area	1.8 x 0.9m
Thickness	23mm core 35mm overall
Weight	40kg

* see www.ground-guards.co.uk

Patents Pending

MultiTrack

WATCH THE VIDEO



Turf protection and safety

Planning the use of Ground-Guards MultiTrack mats into your job before you start can save you from ruining your precious turf. And the extra safety that they provide could also save someone from having a serious accident.

These lightweight plastic mats have now become recognised as standard equipment for use on many sites. They are guaranteed unbreakable by vehicles of up to 120 tonnes which obviously makes them ideal for manoeuvring heavy equipment around on site with minimal disturbance to the turf.

MultiTrack mats are made from environmental friendly 100% recycled plastic, and they range in sizes from 8' x 4' down to 6' x 2' and are available with different tread patterns to suit a whole range of uses. Mats can be quickly fixed together without tools by use of special joining clips.



Without Ground-Guards, wet weather can quickly turn the ground into a quagmire.



"Ask for a demo TODAY!"

Solutions...

- Light to carry and quick to lay
- Eliminate cost of continually replacing slippery splintered plywood boards
- Easy to move around using the Handi- Hook
- Super tough 100% recycled polyethylene plastic 14mm thick - flexible enough to conform to ground contours
- Joiners available for semi-permanent fixture for roadways / carparks
- Guaranteed against breakage by vehicles up to 120 tonnes*

*Note, it is the customer's responsibility to assess the load bearing capacity of the ground and determine what weight of vehicle it is capable of safely supporting. Ground-Guards are not suitable for bridging purposes.



Ground-Guards are convenient to transport, and easy to move around using the Handy Hook.



A wide selection of joining clips are available to suit all applications.

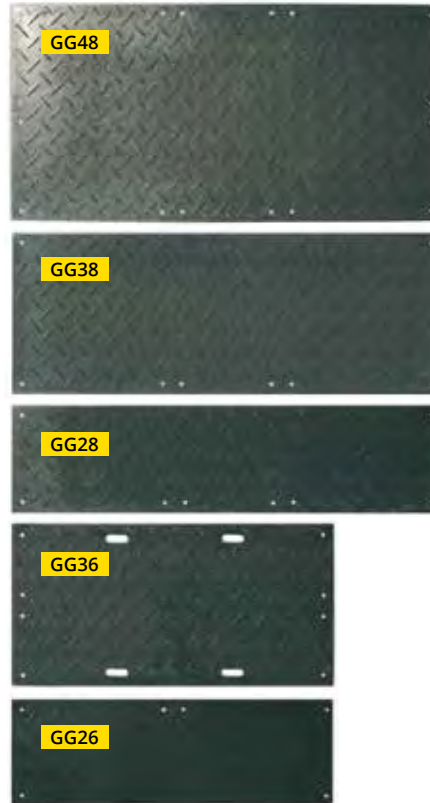

SALE or HIRE			Roadway / Roadway	Smooth / Smooth	Roadway / Smooth	Roadway / Walkway	TREAD OPTIONS
Code	Size	Weight					
MU2412	2.4 x 1.2m (8' x 4')	39kg	•	•	•	•	
MU2409	2.4 x 0.9m (8' x 3')	29kg	•	•	•	•	
MU2406	2.4 x 0.6m (8' x 2')	20kg	•	•	•		
MU1809	1.8 x 0.9m (6' x 3')	22kg	•	•			
MU1806	1.8 x 0.6m (6' x 2')	15kg	•	•			

* see www.ground-guards.co.uk

LiteTrack



WATCH THE VIDEO



Strong, light, ground protection mats

LiteTrack is crafted from a specially recycled LDPE polymer, allowing it to remain flexible enough to follow the contours, yet strong enough to protect your surface.

This cost-conscious system has been created for light vehicles and pedestrian access, making it a great solution for many construction sites and events. The 2.4 x 1.2m LiteTrack mats provide the perfect alternative to using plywood, without incurring the expense of a heavier-duty trackway system.

With a full range of accessories, LiteTrack is fast becoming the system of choice for contractors, events and local authorities.

It's well positioned costing makes it a super investment that will pay dividends for many years to come.

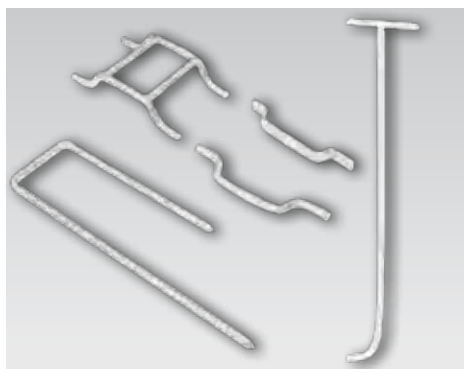

A wide selection of joining clips are available to suit all applications.



SafeStore stillages hold 30 mats



"Ask for a demo TODAY!"

GeoGrid



Solutions...

- Quick and easy to install with simple interlocking design
- Durable and lightweight
- Allows for expansion and contraction reducing risk of surface deformation in hot or cold temperatures
- Ideal for integration into Sustainable Urban Drainage Systems (SUDS)
- Made from 100% recycled polyethylene
- Available in Premium or Standard options

Fast, efficient ground reinforcement

With a cellular grid design that allows rain or flood water to disperse quickly, the GeoGrid paving system is the fast, efficient way to reinforce your ground.

Applications

- Pathways and driveways
- New and overflow car parks
- Ground reinforcement and stabilisation
- Pedestrian access routes
- Access roads
- Event parking
- Road extensions
- Infiltration basins
- Storage areas
- Gateway areas

Specifications

Length	495mm
Width	495mm
Thickness	40mm
Weight	1.1kg (Standard) 1.6kg (Premium)
Axel load*	25 tonnes (Standard) 35 tonnes (Premium)
Compression tested to:	350 tonnes (Standard) 500 tonnes (Premium)

*Subject to correctly engineered installation

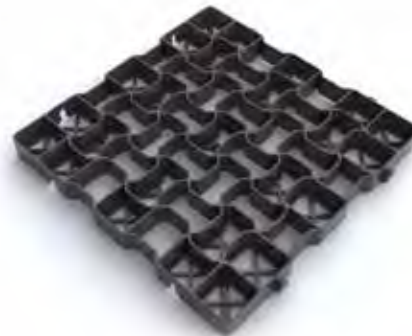

Strong cellular grid modules



Infill with decorative stones or seed with grass



FastCover



WATCH THE VIDEO 

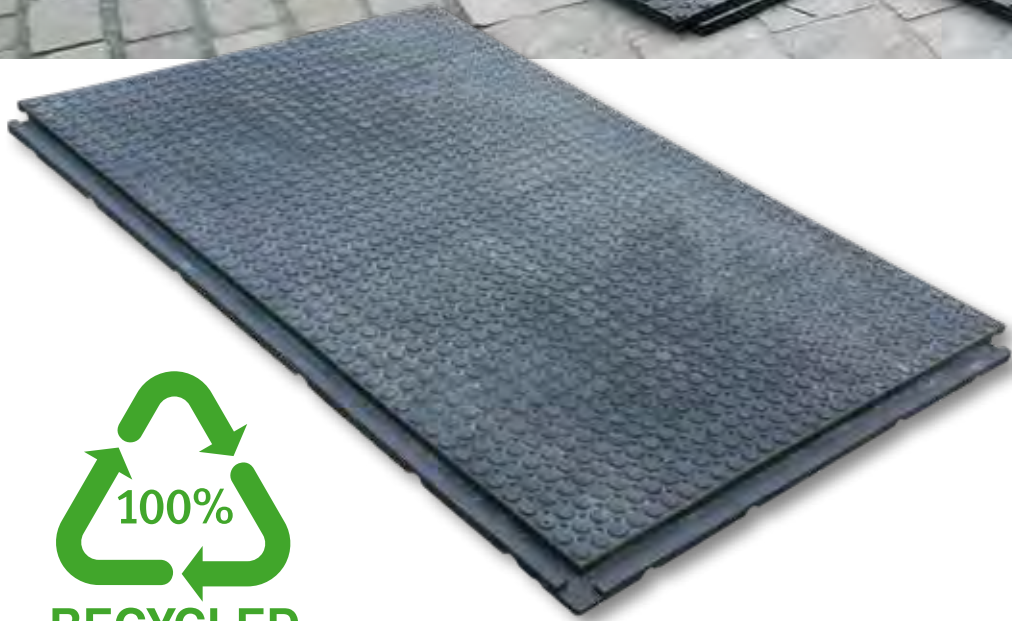

FastCover Flooring

This quick-install flooring system is ideal for a vast range of applications.

These include:

- Pedestrian walkways
- Event flooring
- Marquee flooring
- Factory floors
- Livestock and stables floors

Tiles have interlocking lips for trip-free joining, and are manufactured from 100% recycled PVC.

The FastCover system provides a safe and environmentally friendly solution for the current needs of the construction and events markets.



Product No.	FC102	FC109Z	FC115
Dimensions	1200 x 800 x 43mm including lips (1160 x 760mm usable area)	800 x 600 x 22mm including lips (760 x 560mm usable area)	1200 x 800 x 22mm including lips (1160 x 760mm usable area)
Weight	32kg	12.5kg	20kg
Quantity per pallet	30	100	50
Applications	<ul style="list-style-type: none"> • Footpaths • Walkways • Construction site welfare areas • Motor sport • Temporary car parks over a stone base 	<ul style="list-style-type: none"> • Factory flooring • Plant workshop flooring • Freight hub flooring • Industrial flooring 	<ul style="list-style-type: none"> • Marquee flooring • Pitch cover for events • Livestock flooring • Greenkeepers' shed flooring

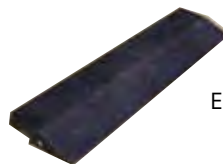

Edging ramps

"Ask for a demo TODAY!"

GreenTek®

GreenTek Solutions Ltd
Rudgate
Thorp Arch Trading Estate
Wetherby
LS23 7AU

T: 0113 267 7000
F: 0113 267 2222
E: info@greentek.uk.com
www.greentek.uk.com



GreenTek



Ground-Guards

**Follow us for our latest updates
and see our GreenTek videos
on YouTube**

